



Strategi

AUTOMATION SOLUTIONS PVT LTD

- ▶ [Company History](#)
- ▶ [Mission and Vision](#)
- ▶ [Our Team](#)
- ▶ [Accolades and Honors](#)
- ▶ [Key Proficiencies](#)
- ▶ [Products, Projects, Service](#)
- ▶ [Our Customers](#)

Company History

About us: What we are and what we do,
Over the years...



What we are & What we do.

Strategi Automation Solutions Pvt. Ltd.

- Leading the field since 1996
- ISO 9001:2015 Certified
- 70+ skilled professionals



AUTOMATION



Why Choose Strategi?

- Custom solutions for every need
- End-to-end automation, seamless integration
- Trusted by top industries

Core Expertise

- Machine building and motion control
- Tailored automation for factories
- 250+ projects delivered
- 200+ machine tending robots installed

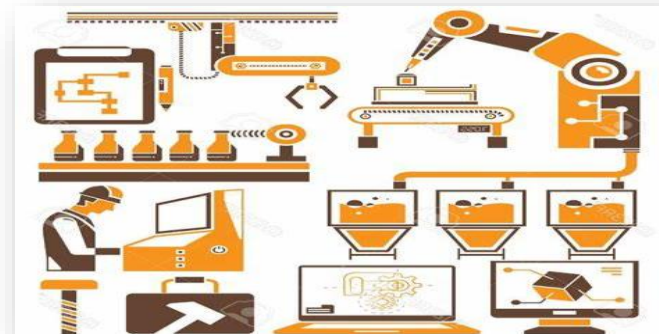

Over the years....

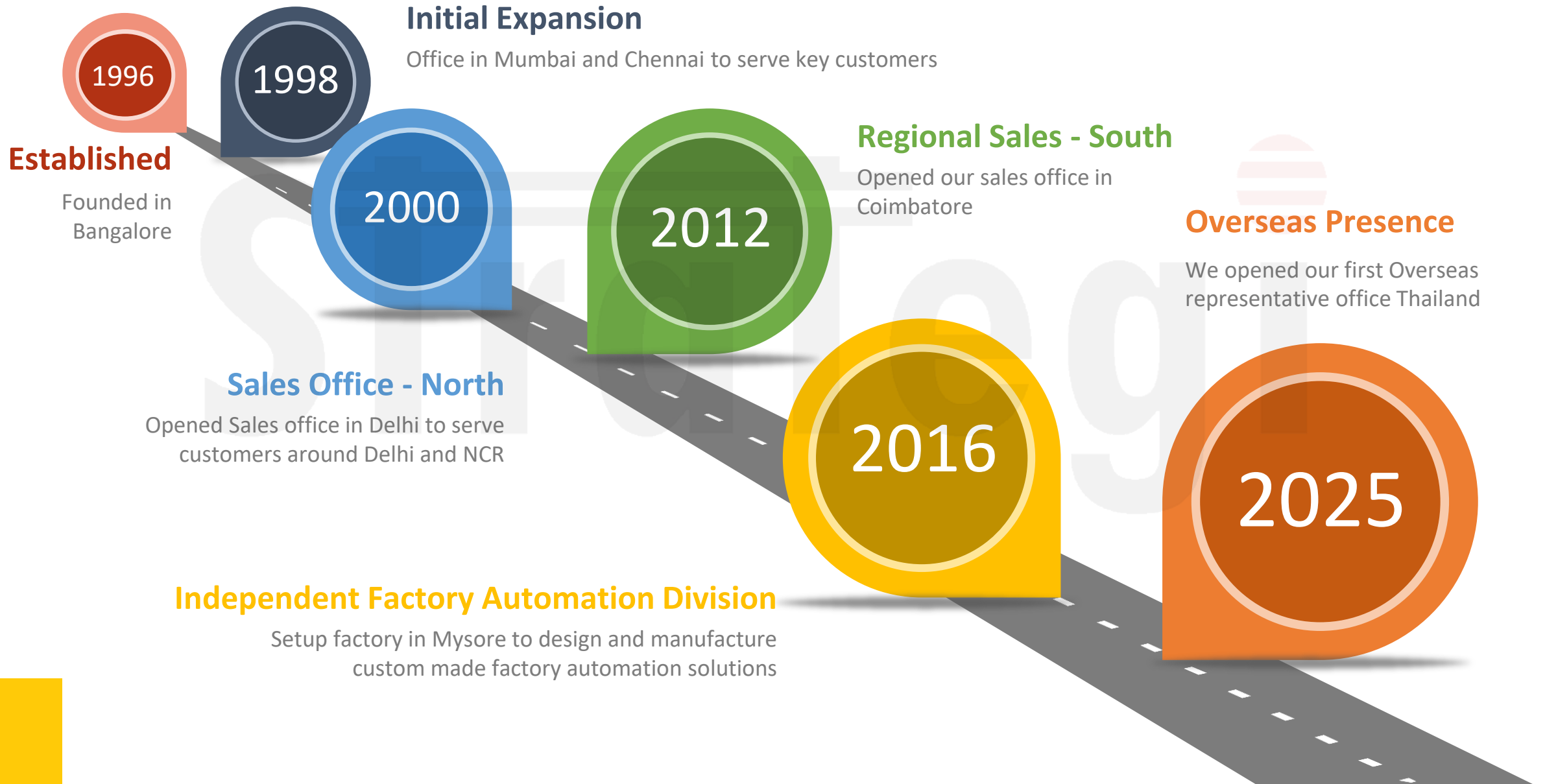

Our Presence....



1. Head Office - Bangalore

Manufacturing location for Electrical System Integration. Own premises of 16000 sq.ft in Whitefield 5000 sq.ft of office space and over 2500 sq.ft of assembly area



2. Factory - Mysore

Manufacturing location for Products & customized Projects. Own premises on a 1acre plot 5000 sq.ft of office space 10000 sq.ft of assembly area.



3. Sales office – Mumbai

4. Sales office – Delhi

5. Sales office – Chennai

6. Sales office – Coimbatore



7. Representative Office – Rayong, Thailand

For Export Business. Promoting our products and projects into ASEAN countries

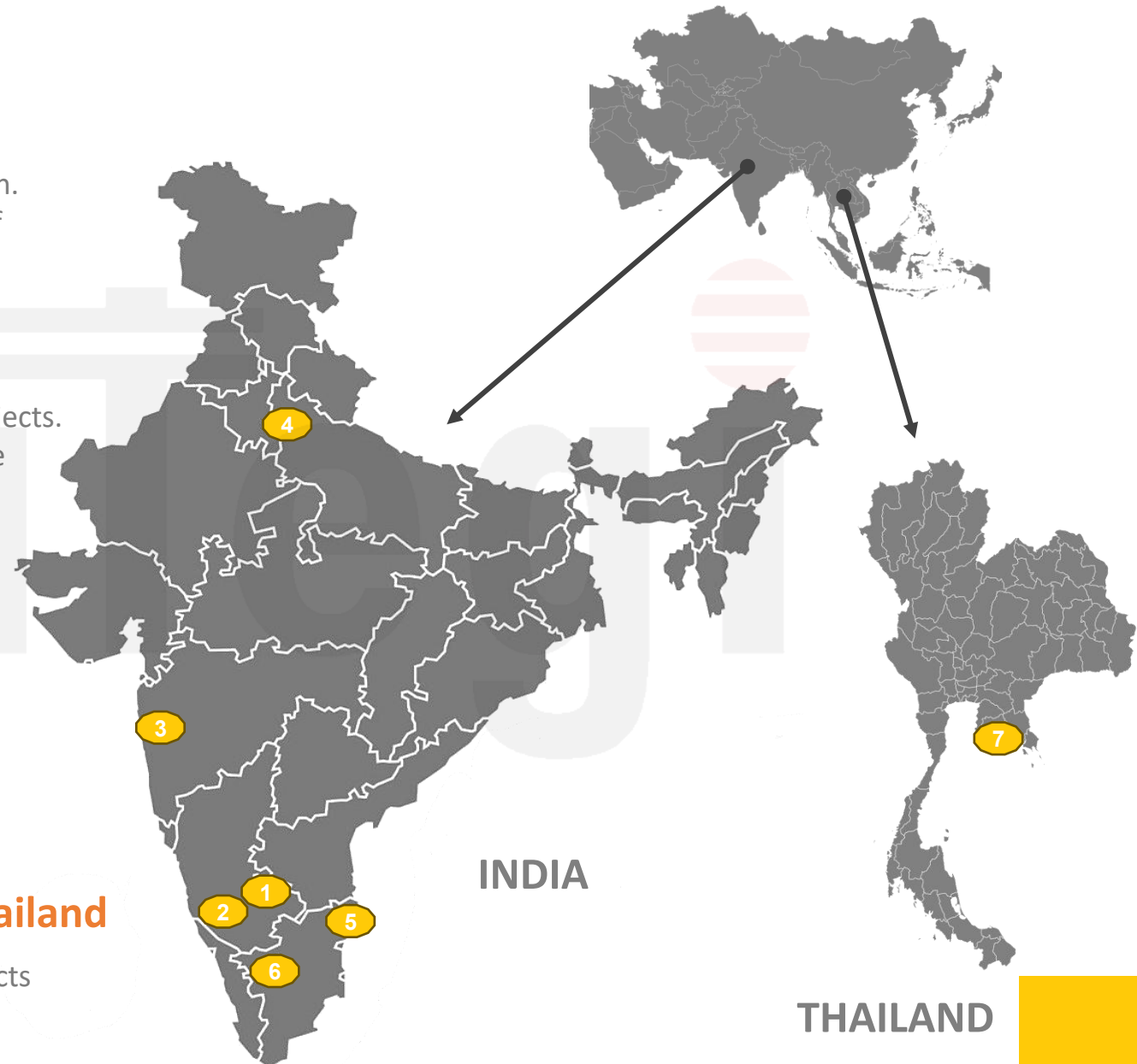

Mission and Vision

Mission Statement

To design and manufacture automation solutions that are reliable and affordable

Vision Statement

Our vision is to eliminate monotonous, repetitive and hazardous jobs in mass manufacturing thus redeploying Labour into more creative and comfortable jobs



Our Team



Unit 1 - Bangalore
Sales and Services



Unit 2 - Mysore
Products and Projects



Arun K Menon
Founder Director



Harish K Menon
Executive Director

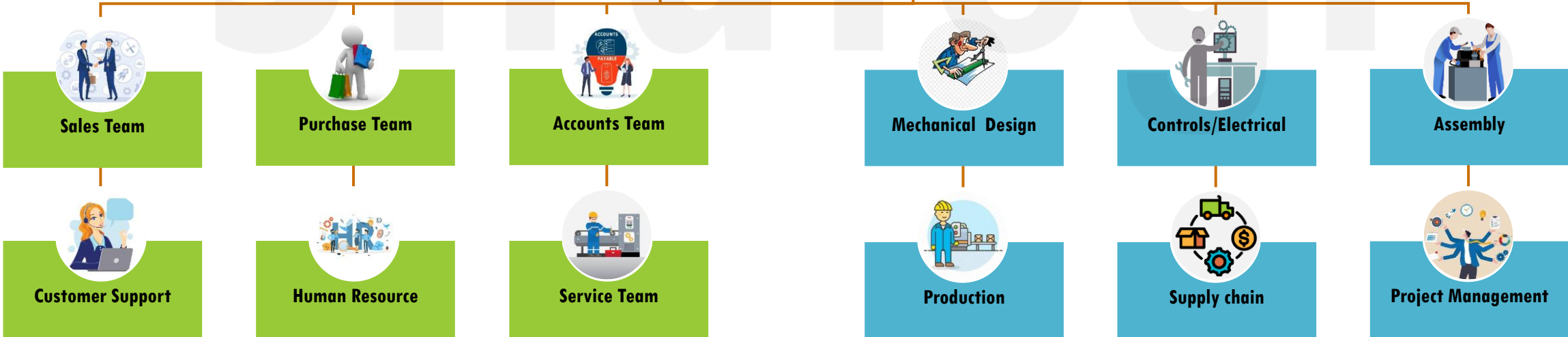

Accolades and Honors



CII Design excellence Award -2017
For Product, Machine Tending Robot



FKCII MSME Innovation Excellence Award -2017
For Product, 5 axes simultaneous milling machine



FIE Foundation Award -2019
For Product, Compliant mechanism



Sector Excellence Award -2025
Winner of the Sector Excellence Award at the Global Investors Meet 2025, Karnataka



Customer testimonials

“Their personnel were knowledgeable and skilled. They were able to execute our project in timely fashion.”

-Dr Sachin Y. Shinde. (Assistant Professor, IIT Kanpur)

1

“They are very flexible. With a clean understanding of our requirements, they delivered the product ”

-Mr. Bhaskaran , MD, Systurn Auto, Hosur

2

“From the moment we contacted your support team, we were impressed with the level of professionalism and commitment demonstrated by everyone”

**-Sathishraj M,
Cluster head – Engineering,
Dr. Reddy's Lab, Vizag**

3

Key Proficiencies

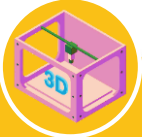

Solid Works

3D modelling,
Simulation and
Analysis



Precision Assembly

Precision Assembly
practices with
alignment fixtures



Finishing Machines

Milling, Grinding and
Drilling machines



Metrology Equipment

All digital gauges
(except CMM)



PLC Programming

Panasonic, Omron,
Mitsubishi, Siemens,
Fatek



HMI Programming

Panasonic, Mitsubishi,
Proface, Fatek, Kinco,
Siemens



PC Based GUI's

Python



Data Acquisition & Storage

Python, Microsoft SQL



IIOT

Machine connectivity
on the cloud



Control Panel

Rittal or equivalent



ERP

SAP B1



Standards & Certification

ISO 9001:2015

Products, Projects & Services

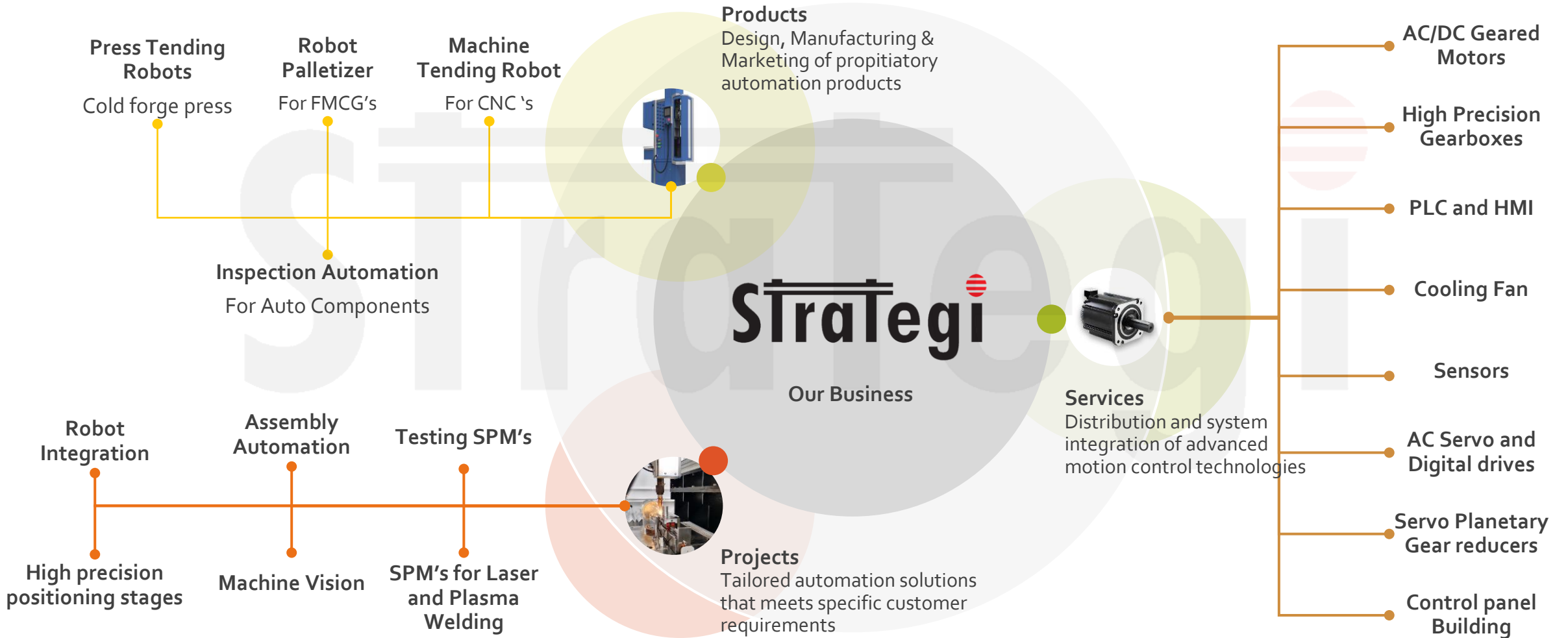



Products and Projects

Our offerings on Products and custom-built projects

Products – Gantry Machine Tending Robot

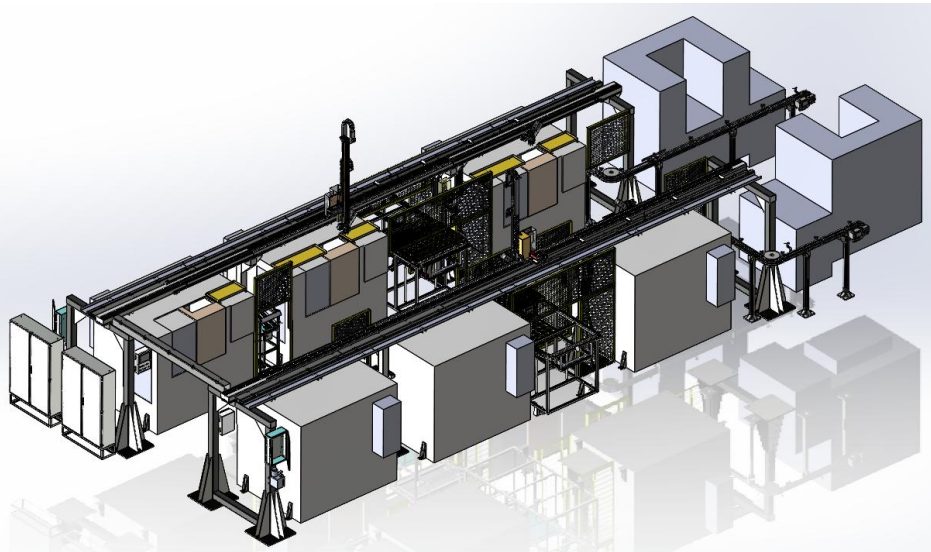

- Designed to Load, Unload parts to CNC Turning Machines
- Allows the operator to view the machining progress.
- Allows the operator to change tools easily.
- Frees the operator to focus more on quality related activities.
- Designed to run 24x7x365.
- Double gripper design.
- Positive gripping while loading and unloading.
- Safe parking zone while machining.
- No cut out on doors required.
- Electrical handshake with machine CNC system for interfacing.
- PLC control.
- Multiple options for Input/Output Gravity, Tray, Conveyor, Stacker, Bowl Feeder etc.
- Payloads from 1- 5Kgs options are available.
- Provided with auto door mechanism to open and close the CNC door
- Can be provided with Auto Inspection and Auto Correction to run with zero defects
- Provided with air jet to flush out chips
- Payback period from 1-3 years

Continue in next page...

Products – Gantry Machine Tending Robot



- Rapid speeds up to 2m/s
- Payload up to 5Kgs. .
- Low floor space footprint
- Load Unload Cycle times of 12-14 seconds
- Can cater to 1-4 machines in a line
- Can take care of Oriented Loading
- Auto inspection and correction can be incorporated
- Can cater to twin spindle machines also effectively

Twin Head Gantry MTR : <https://youtu.be/giuy6K1FPtU>

Unmanned Machining Cell with Gantry MTR : <https://youtu.be/G4iNYDKAltY>

For More Videos Visit :

<https://www.youtube.com/@strategiautomation4617>

Products – Front Load Machine Tending Robot

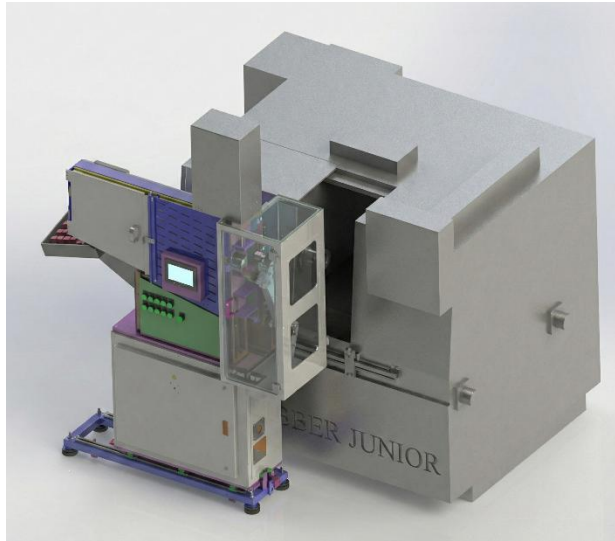

- Payload up to 2Kgs. .
- Suitable for low machining cycle times of 15-20 seconds
- Very Fast Load Unload Cycle times of 8-10 seconds
- Quick installation to cater to a single machine
- Can be easily be moved out for machine repairs and brought back and aligned

Patent Application No: 202541004243

Front Load MTR : <https://youtu.be/WxsCsyncsKw>

For More Videos Visit :

<https://www.youtube.com/@strategiautomationsolution4617>

Products – Inspection Automation

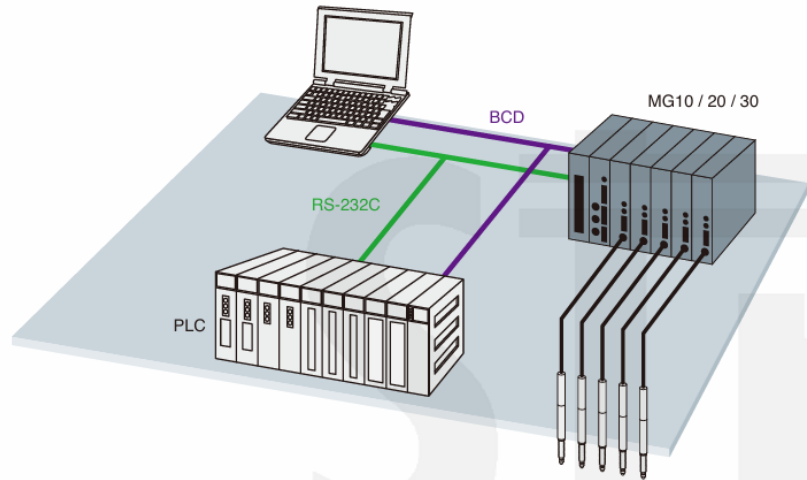

- Multigauge Inspection Station.
- Inspection of Diameters both OD and ID, Length, Flatness etc.
- Stand alone systems or integrated with Robotic loading Unloading systems.
- Can be integrated with auto correction to the CNC.
- Data can be made available on Ethernet IP/Profinet/Modbus TCP/IP.

Inspection Automation : <https://youtu.be/uUYdUDHxWAA>

For More Videos Visit :

<https://www.youtube.com/@strategiautomationsolution4617>

Products – Press Tending Robot



- Designed to load and unload parts to a cold forge press.
- Designed to run 24x7x365.
- Double gripper design, Progressive feeding design.
- Positive gripping while loading and unloading.
- Electrical signal handshake with press with full safety.
- Quick installation.
- Minimal operator intervention.

Press Tending Robot : https://youtu.be/hdPIVCaJ_A4

For More Videos Visit :

<https://www.youtube.com/@strategiautomation4617>

Products – Robotic Palletizer

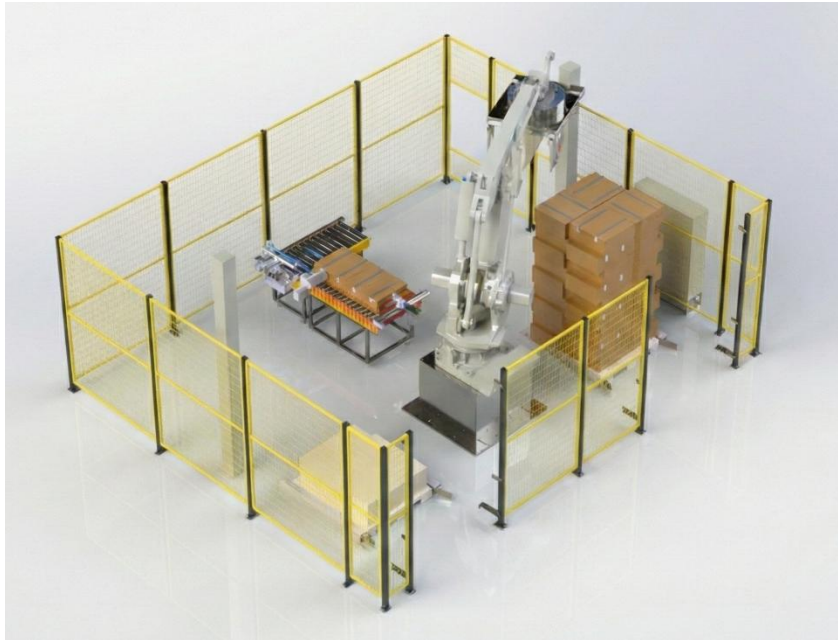

- Can be used to handle multiple carton sizes & types.
- Easy to interface with upstream operations.
- Pneumatic / Vacuum / Mechanical gripping.
- Maximum height of palletizing is <2800mm.
- Palletizing robot of Yaskawa / ABB.
- Gripper assembly for lifting the CBB's.
- Conveyors with dedicated sensors for CBB presence.
- Safety light curtain at the pallet entry point.
- Electrical control panel.
- Safety fencing surrounding the cell.

Robotic Palletizer : <https://youtu.be/nznVkEdCaUo>

For More Videos Visit :

<https://www.youtube.com/@strategiautomation4617>

Products – Case Packer

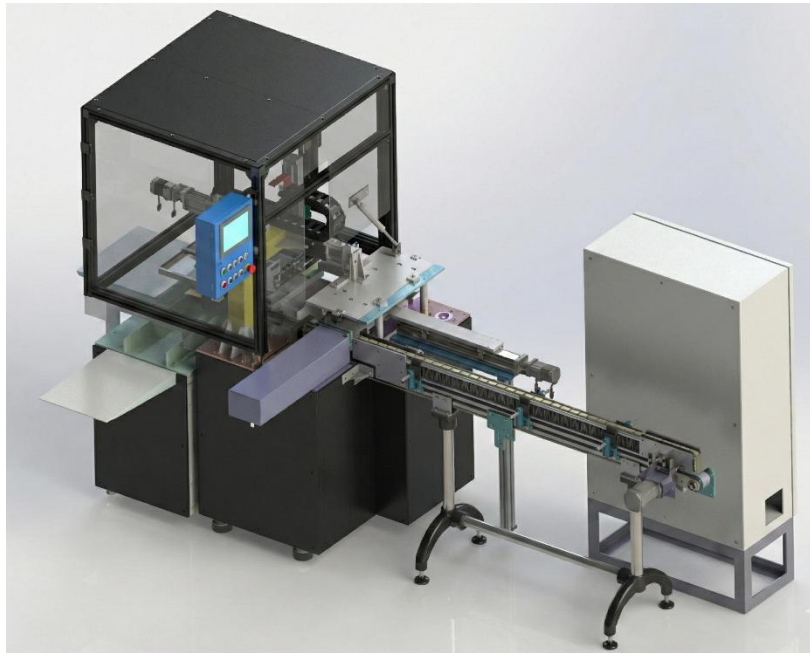

- High-Speed Performance – Up to 180 packs/min with reliable end-of-line case packing
- Flexible Packing Formats – Multiple carton sizes and matrix configurations with quick changeover
- Compact & Rigid Design – Space-saving, vibration-free construction for consistent accuracy
- PLC–HMI Controlled – Easy recipe management, diagnostics, and line integration
- Food-Grade & Safe – Hygienic design with full safety guarding

Case Packer Machine : <https://youtu.be/YrUpZHDIqgl>

For More Videos Visit :

<https://www.youtube.com/@strategiautomation4617>

Products – Semi-Automatic Cartoner

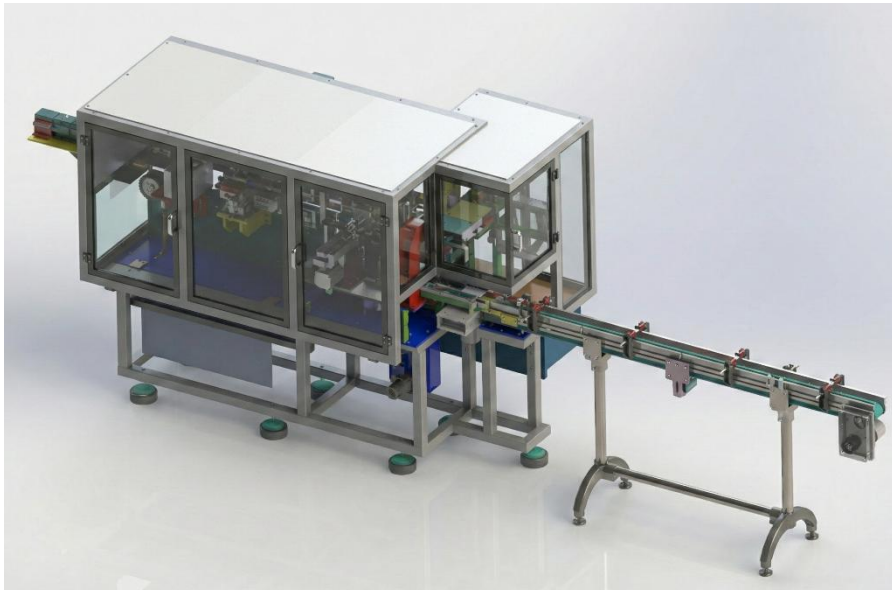

- High-Speed Cartoning – Processes up to 120 packs/min with 24 cartons/min output.
- Semi-Automatic Operation – Manual carton blank loading with automatic opening, filling, and closing.
- Flexible Carton Handling – Supports multiple pack sizes and self-locking / one-side-open cartons with quick changeover.
- Compact & Rigid Design – Space-saving, vibration-free construction for precise and damage-free packing.
- Food-Grade & Safe – Hygienic materials with full 360° safety guarding.

Semi-Automatic Cartoner : <https://youtu.be/b1sJrai63Os>

For More Videos Visit :

<https://www.youtube.com/@strategiautomation4617>

Products – Robotic Deburring



- Ultra-precision finishing with ± 0.02 mm repeatability for consistent edge quality and zero rework.
- Complete deburring in one setup using 6-axis motion for complex edge breaking.
- Flexible tooling options to suit fixed or moving tool configurations.
- Built for reliability with long machine life and wear-resistant gripper systems.
- Multiple deburring methods supported to match material and finish needs.
- Automated pallet change over for uninterrupted, continuous production.

Robotic Deburring : <https://youtube.com/shorts/ybhOopjKVdE>

For More Videos Visit :
<https://www.youtube.com/@strategiautomation4617>

Products – Electric shaker for stamping press

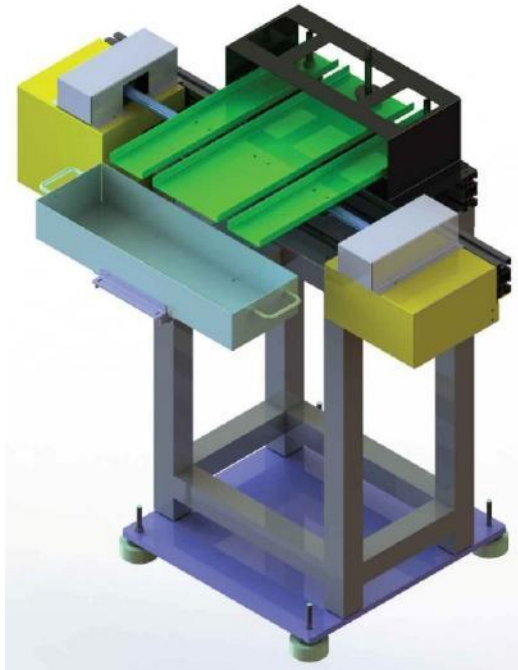

- Electric-driven operation for consistent, controlled vibration and reliable slug removal.
- Robust industrial construction designed for long service life in demanding press shop environments.
- Easy integration with existing progressive and transfer stamping presses.
- Fast ROI and strong payback through reduced stoppages, higher press utilization, and improved throughput.

Electric shaker : <https://youtu.be/mpzT4vPkvoE>

For More Videos Visit :
<https://www.youtube.com/@strategiautomation4617>

Projects – Robot Integration – 6 Axis Robots

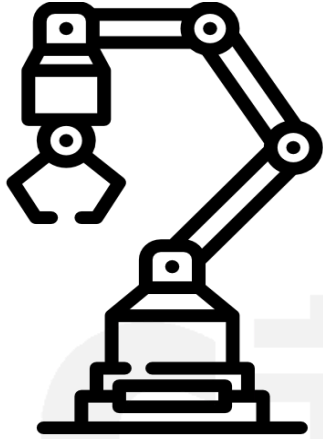

System Integration with standard robots to provide a full solution as a complete Robot Cell with required safety standards

FANUC

YASKAWA

EPSON®



Machine Tending : <https://youtu.be/1NAymkSMYQA>

For More Videos Visit :

<https://www.youtube.com/@strategiautomationsolution4617>

Projects – Robot Integration – SCARA Robots

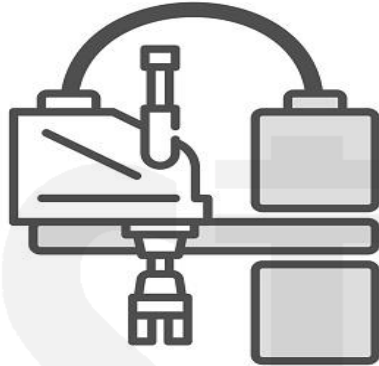

System Integration with standard robots to provide a full solution as a complete Robot Cell with required safety standards



Vision Based Pick And Place : <https://youtu.be/uvZzjOT7pJA>

For More Videos Visit :

<https://www.youtube.com/@strategiautomation4617>

Projects – Robot Integration – Cartesian Robots



System Integration with standard robots to provide a full solution as a complete Robot Cell with required safety standards



Glue Dispensing : <https://youtu.be/xUREGxdlapY>

For More Videos Visit :

<https://www.youtube.com/@strategiautomationsolution4617>

Assembly Automation



- High-Speed Precision – Cam-based rotary table for accurate positioning and smooth operation
- Smart Feeding System – Customized bowl feeder with buffer conveyor for uninterrupted supply
- Zero-Defect Assurance – Integrated inspection of every assembly
- Efficient Sorting – Automatic OK/NOK part ejection
- Versatile & Adaptable – Supports multiple variants with 10-minute changeover
- Optimized Performance – Designed for OEE \geq 90%

Snap Ring Assembly Automation : <https://youtu.be/CbIMtXz2Cbc>

For More Videos Visit :

<https://www.youtube.com/@strategiautomationsolution4617>

End of Line Testing Machines

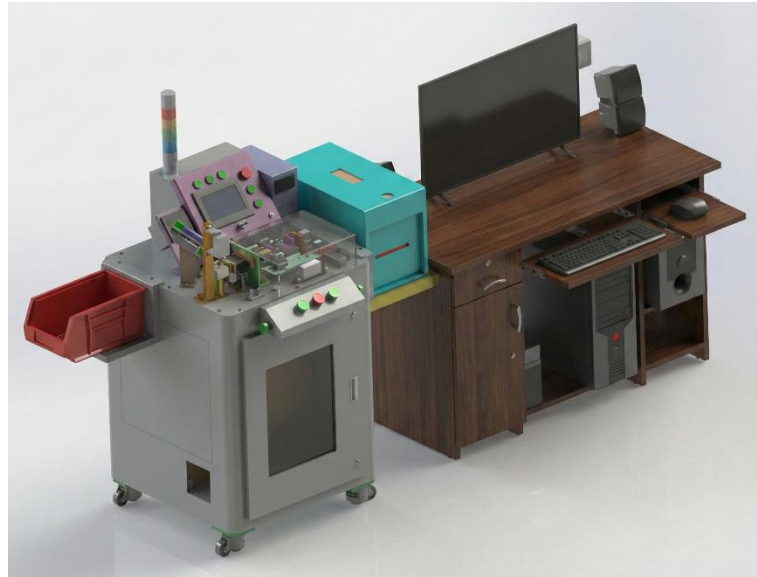

- Ultrasonic testing equipment.
- Torque, Length, Force Measurement.
- Endurance Testing.
- E-Throttle Programming & testing EOL
- E-Seat Latch testing EOL
- Electrical Testing for Solenoid, relays etc.

E seat testing Machine: <https://youtu.be/8qqwBRG2zo0>

For More Videos Visit :

<https://www.youtube.com/@strategiautomationsolution4617>

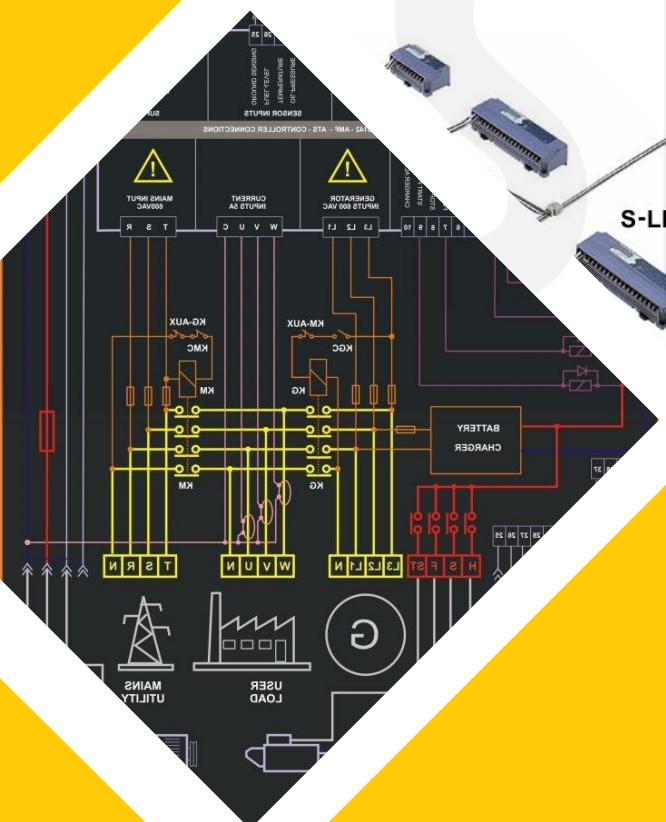

Communication unit
SC-GU3-03
Max. connectable units:
16 units/unit*

Connectable sensors
Digital fiber sensor FX-501/502,
Digital laser sensor LS-501/403,
Digital pressure sensor
DPS-401/402, etc.

Max. 128 units/
master can be
connected



S-LINK V
Gateway controller
SL-VGU1-EC

Max. controllable points:
512 points/unit

All types of ser



S-LINK V

Services

Our offerings for Motion Control Products, Panel Building

Sales and Services

AC/DC Geared Motors



- FHP AC/DC Geared Motors from 6W-300W.
- Gear ratios from 3 to 200.
- Output torque up to 400Nm.
- 1Ø 230V, 3Ø 230V, 3Ø 415V.
- Options for variable speed, brake etc.

High Precision Plano Centric Gear Boxes



- High precision gear boxes <1arc min backlash.
- Component type & full gear box type available.
- Torque up to 7000Nm.
- Full fledged tables up to 9 ton capacity.

Panasonic & Fatek PLC



- Wide range of PLC suitable for small to big range of I/O's.
- Ethernet I/P, Ether CAT Fieldbus options
- Well suited for motion control.

FATEK HMI



- From 4.3 to 15-inch color HMI's.
- Wide range of PLC connectivity.
- RS 232/485/ Ethernet options.
- High Functionality.

Sales and Services

Cooling Fans



SANYO DENKI A Nidec Group Company
SERVO

- Wide range of DC fans, blowers.
- Both axial and centrifugal.
- Available with feedback & PWM control.
- Available with up to IP68 protection.

Sensors



Panasonic
INDUSTRY

- Wide range of Photoelectric, fiber optic and laser sensors.
- Safety light curtains.
- Pressure sensors.
- Micro photo electric sensors.

Multi Axis Motion Controllers



GALIL
WE MOVE THE WORLD

- Multi axis controller from 1-8 axis in conventional type.
- Up to 32 axis of control in Ether CAT.
- Fast update & quick settling time.
- DLL's for easy connectivity to windows & Linux applications.

AC Servo Motors & Digital Servo Drives



Panasonic **FATEK**[®]
INDUSTRY

- 50W to 7.5kW in range.
- Ether CAT servo drives.
- Options for pulse & direction, analog control up to 2kW.
- Incremental & absolute encoder up to 23bit.

Sales and Services



FHP DC Geared Motors

- Wide range of inline & worm DC geared motors.
- Well suited for applications needing high intermittent torque with intermediate duty cycles.



Servo Planetary Gear Reducer

- Wide range of planetary gear boxes in inline & right-angle options.
- Torque up to 2400Nm.
- Backlash <1, <3, <5, <15 arc min options.
- Easy fit to all brand servo motors.

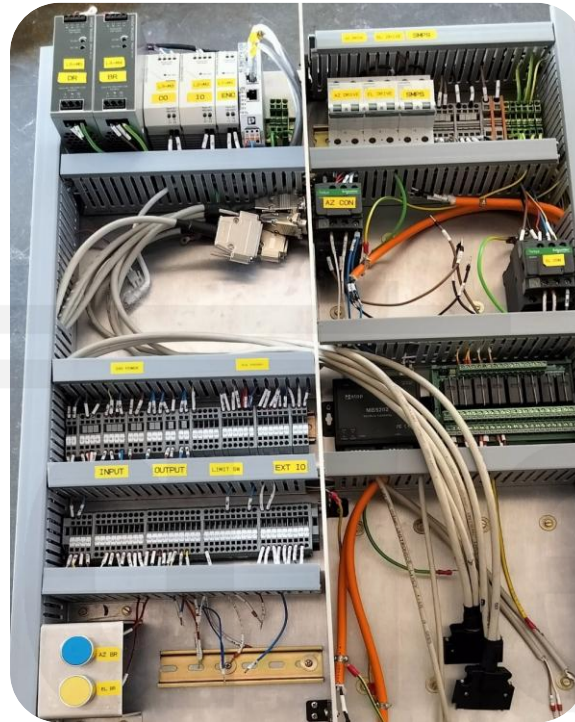

Electrical Control Panel Building

- Design, Manufacture & Testing of Electrical Control Panels with PLC, Servos and Motion Controllers.
- Options for various PLC brands- Panasonic, Omron, Siemens etc.

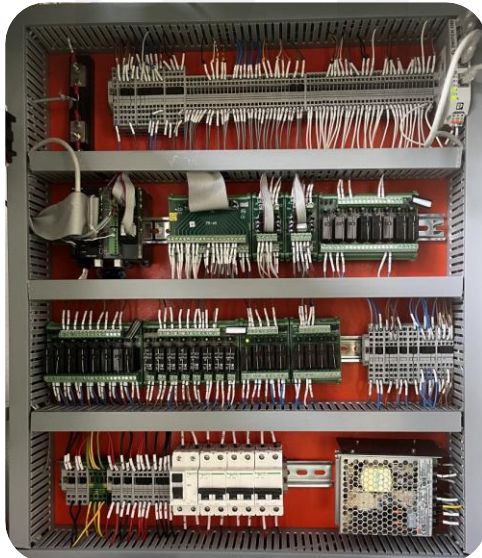

Our Esteemed Customers



భారతీయ సాంకేతిక విజ్ఞాన సంస్థ హైదరాబాద్
भारतीय प्रौद्योगिकी संस्थान हैदराबाद
Indian Institute of Technology Hyderabad



IIT Madras



CIE India



Sundram Fasteners Limited

Thank you

Bangalore :

Strategi Automation Solutions Pvt. Ltd.
25/B, Doddanakundi Industrial Estate, Off Whitefield Road,
Behind Graphite India,
Bangalore – 560 048.
Email : sales@strategiautomation.com

Mysore:

Strategi Automation Solutions Pvt. Ltd.
Plot 131, Kadakola Industrial Area,
Mysore 571 311.
Email : sales@strategiautomation.com

Thailand :

Mr. Anandan
Asst. Manager - Business Development
C/O Genesis Engineering,
111/2, Moo3, T. Chakbok, A.Bankai, Rayong-21120, Thailand
Email : sales@strategiautomation.com

